

Leisure käynnistysakut



- Erityisesti vapaa-ajan sovelluksiin
- Pitkä varastointiaika
- Maksimoitu käytöturvallisuus
- Hyvä syväpurkauksen kesto

Kuvaus

Leisure-sarjan akut ovat suunniteltuja Euroopassa käytettäviin vapaa-ajan sovelluksiin. Hyvä kylmäkäynnistysarvo, purkuaika ja syväpurkauksen kesto, tekevät sarjan akuista erinomaisia mm. asuntovaunun käyttöön.

Tilausnumerot

Tilausnumero	Jännite V	Kapasiteetti		Mitat			Paino Kg	Napaisuus	Napa	Kiinnitys
		Virta Ah	Käynnistysvirta CCA/EN	Pituus	Leveys	Korkeus				
L26-70	12	70	480	260	174	225	18,5	1	T1	B5
L26-80	12	80	560	260	174	225	19	1	T1	B5
L35-90	12	90	680	346	173	233	24,5	1	T1	N
L35-100	12	100	720	346	173	233	26	1	T1	N
L35-115	12	115	750	345	172	232	29,2	1	T1	N
L36-100	12	100	900	353	175	190	23,3	0	T1	B3
L26-AGM	12	90	300	259	168	232	27	1	T1	N
L36-AGM	12	95	850	353	175	190	25,6	0	T1	B3

Napaisuus

6 VOLT

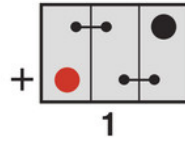
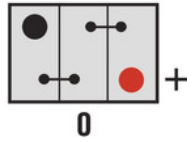

12 VOLT

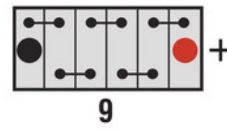
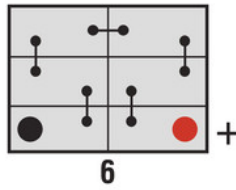
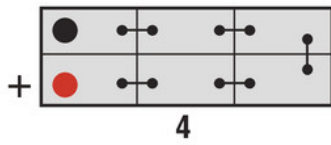
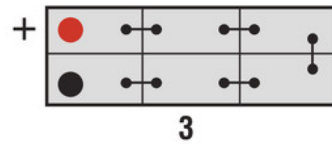
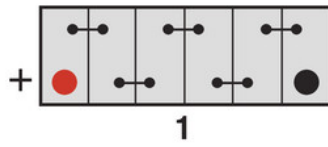
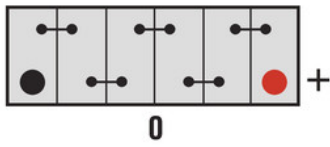

Asennustapa

N

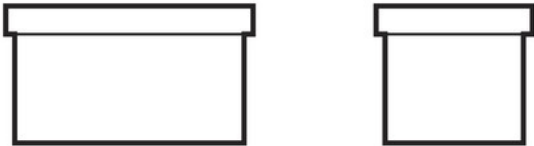

B1

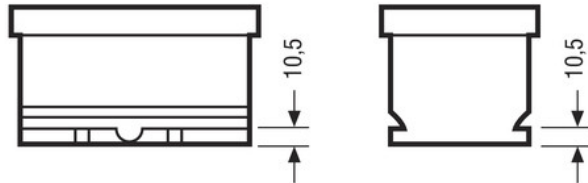

B3

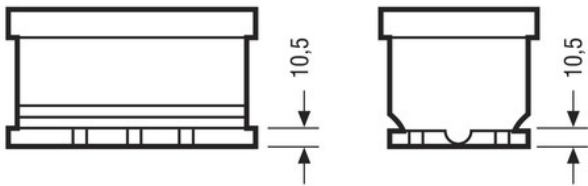

B5

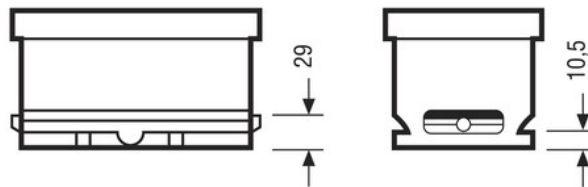

B3/B4 (B3 with Hold-Down adaptor 23288996)

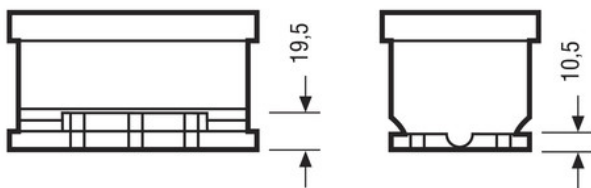

B12

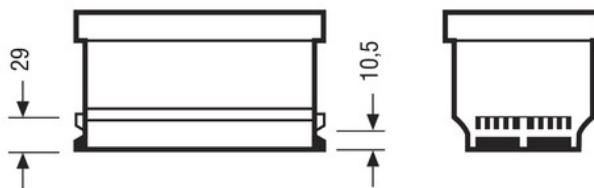

Napatyyppi

T1 Standard DIN Post

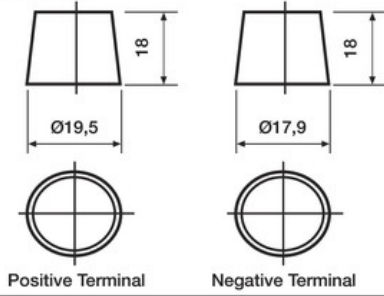

T3 Small Japanese JIS Terminal

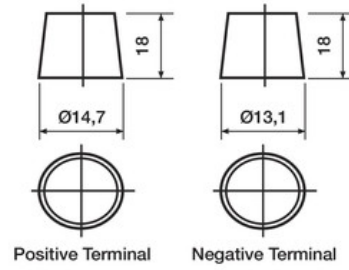

T4-F

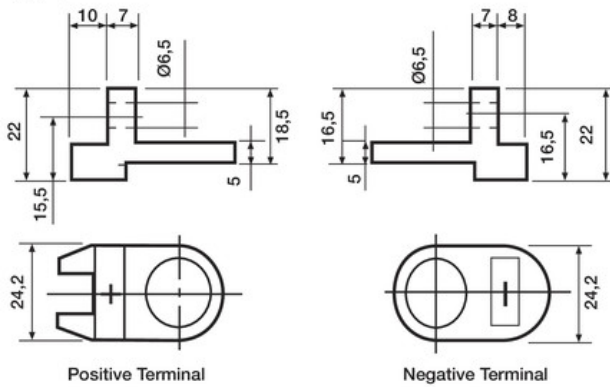

T4

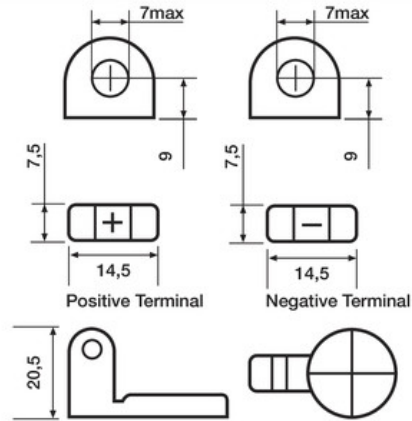

T9 Classic 702/703/721/722

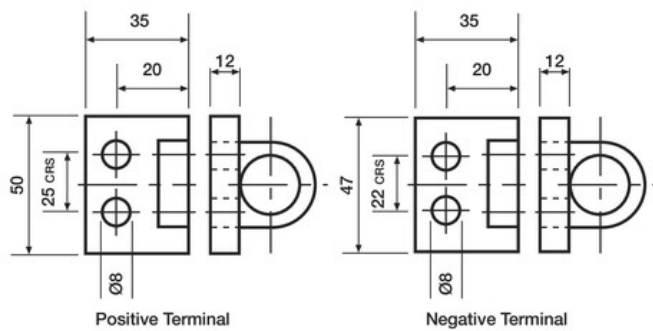

T8 Ford Cargo Terminal use adapter kit (order 23292114)

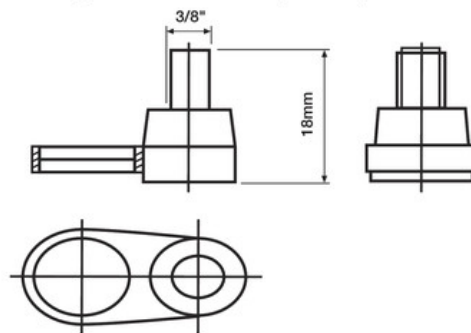

TM Marine Dual Terminals

